

REV  
NC  
**DTM06-12S\***

REVISIONS			
SYM	DESCRIPTION	DATE	APPROVED
NC	NEW RELEASE PER E.O. P17240	4-19-01	RDR

- 7. SEE SHEET 2 FOR OTHER KEY ARRANGEMENTS.
- 6. MATERIAL - HOUSING: PLASTIC; GROMMET: RUBBER.
- 5. THIS PLUG MATES WITH DTM04-12P\*-\*\*\*\* RECEPTACLE.  
(\* = A,B,C,D KEYS; \*\*\*\* = ALL MODIFICATIONS)
- 4. FOR CONTACT AND WIRE PERFORMANCE AND APPLICATION CHARACTERISTICS SEE ENVELOPE DRAWING 0425-015-0000.
- 3. SECONDARY WEDGE LOCK SOLD SEPARATELY: WM-12S.
- 2. DIMENSION TOLERANCE: ±.025 [.64].
- 1. DIMENSIONS ARE IN INCHES [mm].

NOTES: UNLESS OTHERWISE SPECIFIED

CONTACT SIZE	MIN. INSUL. O.D.	MAX. INSUL. O.D.	WIRE RANGE [mm <sup>2</sup> ] REF ONLY
20	.053 [1.35]	.120 [3.05]	16-22 AWG [1.0-0.5]

SIGNATURE & DATE	
DR	J. APOSTOL 17APR2001
CHK	R. Meyer 4/18/01
PE	D. Meyer 4/17/01
APPD	R. Reed 4-19-01
SCALE	NONE WT

PLUG  
12 CONTACTS, SIZE 20  
A, B, C, D KEYS  
DTM SERIES

ENVELOPE

CP	MATL. CODE
<b>The Deutsch Company</b> DEUTSCH I.P.D. 3850 INDUSTRIAL AVE. HEMET, CALIF. 92545	
<b>B</b>	<b>DTM06-12S*</b>
DWG SIZE	CODE 11139 SHEET 1 OF 2

REV  
NC DTM06-12S\*

REVISIONS			
SYM	DESCRIPTION	DATE	APPROVED
	SEE SHEET ONE	4-19-01	RDR

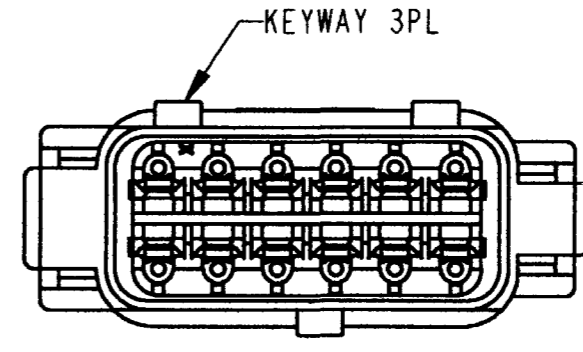
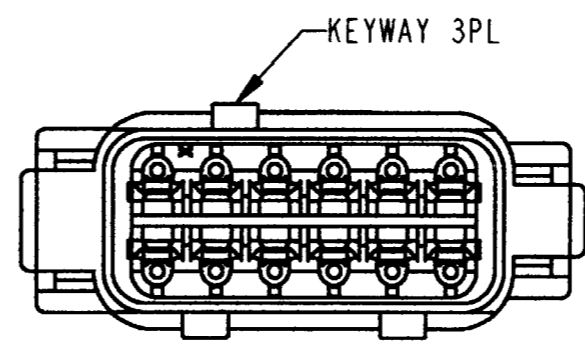
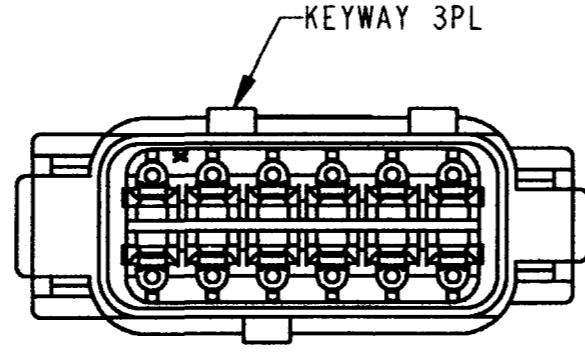
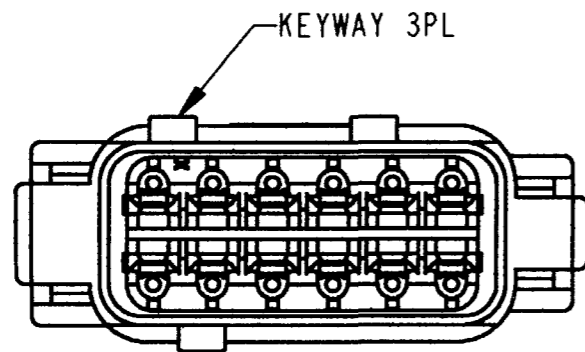
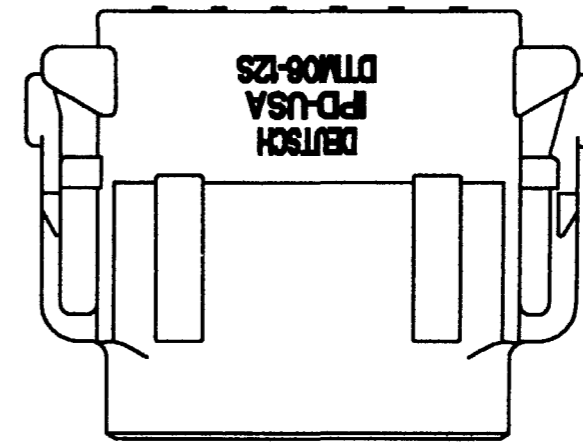
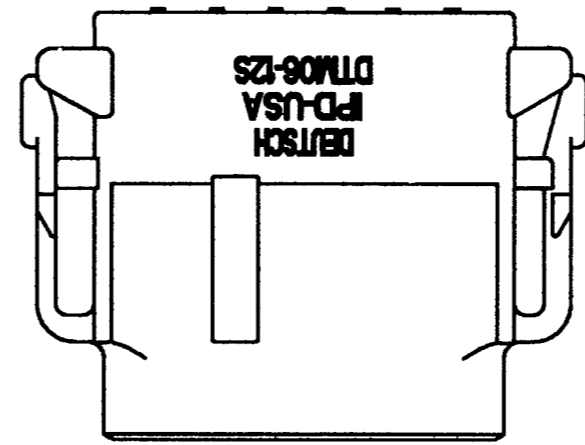
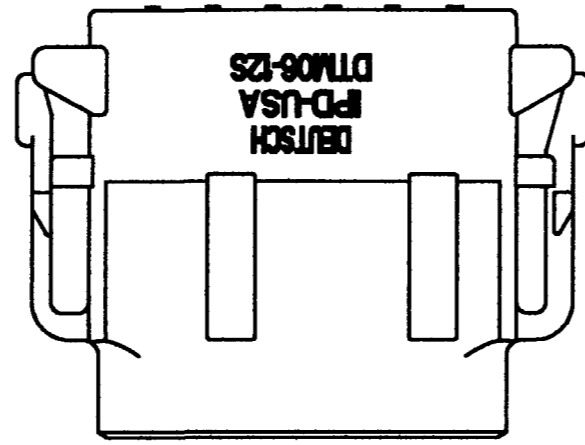
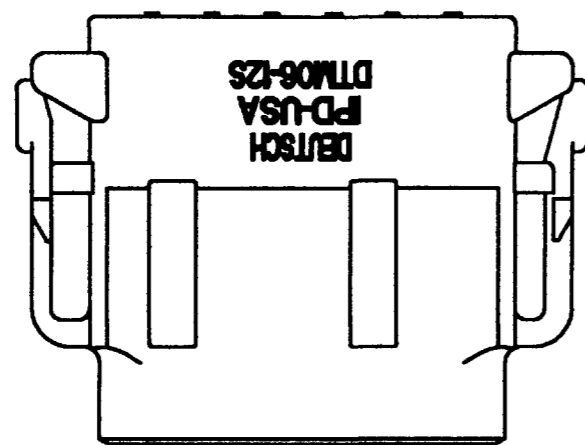

DTM06-12SA  
KEY -A-  
COLOR: GREY

DTM06-12SB  
KEY -B-  
COLOR: BLACK

DTM06-12SC  
KEY -C-  
COLOR: GREEN

DTM06-12SD  
KEY -D-  
COLOR: BROWN

NOTES:

SIGNATURE & DATE		PLUG 12 CONTACTS, SIZE 20 A,B,C,D KEYS DTM SERIES	CP	MATL. CODE	
DR	J. APOSTOL 17APR2001		The Deutch Company DEUTSCH I.P.D. 3850 INDUSTRIAL AVE. HEMET, CALIF. 92545		
CHK	Rmly 4/18/01		B	DTM06-12S*	
PE	D Meyer 4/17/01			DWG SIZE	CODE 11139
APPD		ENVELOPE			
SCALE	NONE	WT			